

SOFIA PROFESSIONAL 48"

48" DUAL FUEL PROFESSIONAL RANGE











CODE ID









F6PDF486GS1



-  Heavy Duty Grates
-  Continuous Grate Surface
-  Dual Crescendo Burner
-  Trilaminated Stainless Steel Griddle
-  Dual Convection (main oven)
-  True Convection (accessory oven)
-  Soft Closing Door
-  Self Clean Ovens
-  Multi-level cooking
-  1 Telescopic Rack
-  Cool Touch Door
-  Digital Controls
-  Meat Probe (main oven)
-  Fast Pre-Heat

COLOR KIT

	STAINLESS STEEL
	MATTE BLACK RAL 9004
	GLOSSY BLACK RAL 9004
	GLOSSY RED RAL 3003
	GLOSSY WHITE RAL 9016
	MATTE GREY RAL 9007
	MATTE WHITE RAL 9016

OPTIONAL ACCESSORIES

PDRKIT48 ...	Colour kit
FMWOK	Wok ring
FMSIM	Simmer plate
F6BG48BCI	Island trim
F6BG48STD	Standard trim
F6BG48HBT	High back trim
FMTRP30	Griddle
FMTRP18	Telescopic rack

COOKING SURFACE

3 Heavy Duty, continuous cast iron grates
Trilaminated Stainless Steel Griddle with
Tubular Gas Burner
11,500 BTU high / 2,000 BTU low
Matte finish porcelain burner bowl
6 Dual-Flame Crescendo Burners
2 X 20,000 BTU max (NG)
4 X 18,000 BTU max (NG)
Natural Gas (LP convertible)

Ovens

Dual True Convection in main oven and
True Convection in accessory oven
Self-cleaning oven with Multifunction baking
Black Porcelain enamel interior
Cool to the touch, soft closing door
Extra-large baking cavity and viewing area
3 Halogen lights on main oven
1 Halogen light on convenience oven
Gross capacity 4.4 cu. ft. and 2.7 cu. ft.
2 chromed racks
1 telescopic rack per oven

Oven Functions

Bake
Broil
Roast
Convection
True Convection
Warm / Proof / Dehydrate
Electronic cooking programmer
Meat Probe on main oven only
Self-Clean
Sabbath Mode

SOFIA

48" DUAL FUEL PROFESSIONAL RANGE

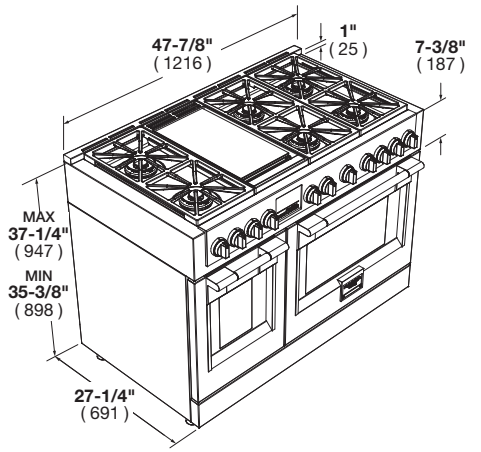

CODE ID	F6PDF486GS1 - 48" DUAL FUEL PROFESSIONAL RANGE			
Series and Finish	600 Series - Professional Design - Stainless Steel			
CONTROL PANEL				
Control Type	11 Heavy Duty Knobs			
Oven Programming	Electronic with 6 Touch Keys			
Display: Clock - Temperature - Function	English language - White LED			
COOKTOP				
Type	GAS (NG or LP)			
Cooking Surface	Matte Black Enamel			
GAS COOKTOP FEATURES				
	Electric Re-ignition system	Dual Crown Burners (Brass or Alluminum)		
	Flame-out sensing	Griddle (flat or with rack)		
	Top Mount Injectors	Pressure Regulator		
	L.P. Conversion Kit	3 Heavy Duty Cast Iron Grates		
Cooking Zones	6 Burner + Griddle			
Burners types	All Dual Flame/Simmer Burner			
Front-L/Front-R - Pwr (Max/Min) G20-5" / G31-10"	20000 (BTU/h) - 5850W / 750 (BTU/h) - 220W		15000 (BTU/h) - 4400W / 750 (BTU/h) - 220W	
Rear-L/Front Center "Right"/Rear Center "Right"/Rear-R - Power (Max/Min) G20 - 5" / G31 - 10"	18000 (BTU/h) - 5300W / 750 (BTU/h) - 220W		15000 (BTU/h) - 4400W / 750 (BTU/h) - 220W	
Griddle Burner (Center "Left")	Thermostat Control Griddle Burner - 11500 (BTU/h) - 3370W / 2000 (BTU/h) - 590W			
OVEN	18" (Accessory Oven)		30" (Main Oven)	
Type	Electric Self-clean - Dual Convection (True Euro Conv.)		Electric Self-clean - Dual Convection (True Euro Conv.)	
Temperature Regulation	Electronic Control (min/max 170/550°F - 75/290°C)		Electronic Control (min/max 170/550°F - 75/290°C)	
OVEN FUNCTIONS				
	Pyrolytic Self-Clean with automatic door latch	Bake	Pyrolytic Self-Clean with automatic door latch	Bake
	Convection Broil	Broil	Convection Broil	Broil
	Pizza (Lower Convection)	Oven Lights	Pizza (Lower Convection)	Oven Lights
ELECTRIC OVEN FEATURES				
	Preset/Last Used Temperature Memory	Preheat Indicator (25%, 50%, 75%, 100%)	Preset/Last Used Temperature Memory	Preheat Indicator (25%, 50%, 75%, 100%)
	Child Door Lock	Control Display Lock	Child Door Lock	Control Display Lock
	Automatic Fast Preheat	12/24 Hour Clock Formats	Automatic Fast Preheat	12/24 Hour Clock Formats
	Sabbath Mode	Temperature Display °C/°F	Sabbath Mode	Temperature Display °C/°F
			Meat Probe	
OVEN DOOR(S)				
Oven Glass Window	Deep Embossed Window		Deep Embossed Window	
Door Cooling System	4 Heat Resistant Glasses		4 Heat Resistant Glasses	
Door Hinges - Soft-closing System	Heavy Duty Steady Tilt		Heavy Duty Steady Tilt	
Handle Style	Stainless Steel Tube Ø30mm, Metal End caps		Stainless Steel Tube Ø30mm, Metal End caps	
OVEN CAVITY				
Gross Capacity (cbft)	2.7		4.4	
Usable Capacity (cbft)	2.4		4.1	
Cavity Enamel Colour	Black		Black	
Rack Positions	6		6	
Oven Lights	2x20W Halogen		3x20W Halogen	
HEATING ELEMENTS (@240V)				
Broil Upper Heating Element	2100 W		3500 W	
Upper Auxiliary Element	700 W		1032 W	
Concealed Bake Lower Heating Element	1750 W		3000 W	
Convection Element	1 x 2500 W		2 x 1300 W	
OVEN ACCESSORIES				
Chromed Racks	2		2	
Enameled Broiler Pan (basin + anti splash)	-		1	
Telescopic Chromed Rack	1		1	
DIMENSIONS/WEIGHT				
Overall dim - Width	47 - 3/4" (1216 mm)			
Overall dim - Height (min - max)	36 3/8", 38 1/4" (923 mm) - (972 mm)			
Overall dim - Depth	29 - 3/4" (756 mm)			
Gross Weight	529 lbs (240 kg)			
POWER / RATINGS (208/240 V, 60 HZ)				
kW / Amps rating at 120-240V, 60Hz	6.08 kW - 26.7A			
kW / Amps rating at 120-208V, 60Hz	5.73 kW - 28.3A			
Power Cable	Nema 14-50P			
INSTRUCTIONS FOR USE				
Use & Care Manual / Installation Manual	English / French / Spanish			