

SOFIA PROFESSIONAL 36"

36" INDUCTION PROFESSIONAL RANGE



CODE ID



F6PIR36S1



 Easy Clean Ceramic Glass

 Power Boost Burner

 Dual Max Power

 Pan Detection system

 Residual Heat Sensor

 Soft Closing Door

 Self Clean Oven

 Multi-level cooking

 1 Telescopic Rack







 Cool Touch Door

 Digital Controls

 Meat Probe

 Fast Pre-Heat

COLOR KIT

	STAINLESS STEEL
	MATTE BLACK RAL 9004
	GLOSSY BLACK RAL 9004
	GLOSSY RED RAL 3003
	GLOSSY WHITE RAL 9016
	MATTE GREY RAL 9007
	MATTE WHITE RAL 9016

OPTIONAL ACCESSORIES

PDRKIT36 ...	Colour kit
F6BG36BCI	Island trim
F6BG36STD	Standard trim
F6BG36HBT	High back trim
INDUKIT4	Induction plate adapters
FMTRP36	Telescopic rack

COOKING SURFACE

4 Single Induction cooking zones
1 Dual Max Power with Ø 11" cooking zone
Elegant Ceramic glass surface
Premium induction technology for unsurpassed performance
Booster function for each cooking zone
Residual heat and Power-on Indicators
Melting and Simmering function
Knob Controlled
Digital Minute Minder
Pot Detection System
Child Lock Function

OVEN

Dual True Convection
Self-cleaning oven with Multifunction baking
Black Porcelain enamel interior
Cool to the touch, soft closing door
Extra-large baking cavity and viewing area
3 Halogen lights for flawless visibility
Gross capacity 5.7 cu. ft.
2 chromed racks
1 telescopic rack
Enameled Broiler Pan

OVEN FUNCTIONS

Bake
Broil
Roast
Convection
True Convection
Warm / Proof / Dehydrate
Electronic cooking programmer
Meat Probe
Self-Clean
Sabbath Mode

SOFIA

36" INDUCTION PROFESSIONAL RANGE

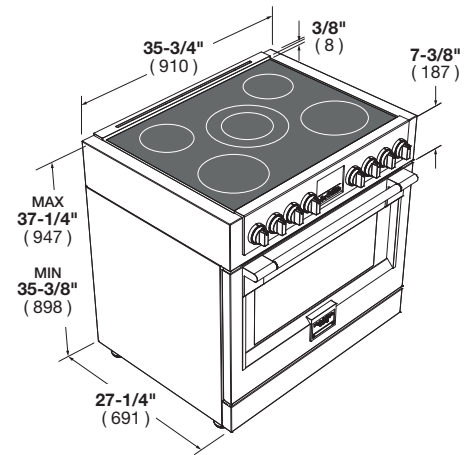

CODE ID	F6PIR365S1 - 36" INDUCTION PROFESSIONAL RANGE			
Series and Finish	600 series - Professional Design - Stainless Steel			
CONTROL PANEL				
Control Type	8 Heavy Duty Knobs			
Oven Programming	Electronic with 6 Touch Keys			
Display: Clock - Temperature - Function	White LED			
Language	English			
COOKTOP				
Type	INDUCTION			
Cooking Surface	Ceramic Glass			
INDUCTION COOKTOP FEATURES				
	Pot Detection System	Residual Heat Indication		
	Melting Function 113°F / 45°C	Simmering Function 158°F / 70°C		
	Digital Display for Power Level	Booster/Fast Boil Function for Each Zone		
	Failure Codes Indication	Power Levels: 1 to 9		
	Cooling Fan System	Heat up time automatic		
	Child Lock Function	Digital minute minder		
	Knob for power setting	Cooking Zones: 5		
Burners types (Front-L) - Power (Max/Booster)	Inductor 9"	(23z0 mm)	2300W / 3700W	
Burners types (Rear-L) - Power (Max/Booster)	Inductor 7"	(180 mm)	1850W / 3000W	
Burners types (Center dual circuit) - Power (Max/Booster)	Inductor 11"	(280 mm)	3000W / 5500W	
Burners types (Center single circuit) - Power (Max/Booster)	Inductor 7"	(180 mm)	1850W / 2600W	
Burners types (Front-R) - Power (Max/Booster)	Inductor 9"	(230 mm)	2300W / 3700W	
Burners types (Rear-R) - Power (Max/Booster)	Inductor 7"	(180 mm)	1850W / 3000W	
OVEN				
Type	Electric Self-clean - Dual Convection (True Euro Conv.)			
Temperature Regulation	Electronic Control (min/max 170/550°F - 75/290°C)			
OVEN FUNCTIONS				
	Pyrolytic Self-Clean	Convection Roast	Broil	Proof (Warm)
	True Convection	Pizza (Lower Convection)	Dehydrate	Keep warm (Warm Plus)
	Convection Broil	Bake	Thaw (Defrost)	Oven Lights
ELECTRIC OVEN FEATURES				
	Preset/Last Used Temperature Memory	Automatic Fast Preheat Sabbath Mode	Preheat Indicator (25%, 50%, 75%, 100%)	12/24 Hour Clock Formats Temperature Display °C/°F
	Child Door Lock	Meat Probe	Control Display Lock	
OVEN DOOR(S)				
Oven Glass Window	Deep Embossed Window			
Door Cooling System	4 Heat Resistant Glasses			
Door Hinges - Soft-closing System	Heavy Duty Steady Tilt			
Handle Style	Stainless Steel Tube Ø30mm, Pro Style			
OVEN CAVITY				
Gross Capacity (cbft)	5.7			
Usable Capacity (cbft)	4.9			
Cavity Enamel Colour	Black			
Rack Positions	6			
Oven Lights	3x20W Halogen			
HEATING ELEMENTS (@240V)				
Broil Upper Heating Element	3500 W			
Upper Auxiliary Element	1032 W			
Concealed Bake Lower Heating Element	3000 W			
Convection Element	2 x 1300 W			
OVEN ACCESSORIES				
	2 Chromed Racks	1 Telescopic Chromed Rack		
	1 Enameled Broiler Pan (basin + anti splash)			
DIMENSIONS/WEIGHT				
Overall dim - Width	35 - 3/4"	(910 mm)		
Overall dim - Height (min - max)	36 3/8", 38 1/4"	(923 mm) - (972 mm)		
Overall dim - Depth	29 - 3/4"	(756 mm)		
Gross Weight	382 lbs	(174 kg)		
POWER / RATINGS (208/240 V, 60 HZ)				
kW / Amps rating at 120-240V, 60Hz	12kW - 45.8A (Limited Maximum Output Amp.)			
kW / Amps rating at 120-208V, 60Hz	10kW - 48.5A (Limited Maximum Output Amp.)			
Power Cable	Nema 14-50P			
INSTRUCTIONS FOR USE				
Use & Care Manual / Installation Manual	English / French / Spanish			