



## Microwave oven 75x45

FUGMO 7505 MT IX



- Stainless steel finish
- Metal knobs
- 3 functions
- Digit Timer (on-off) | Knobs
- Microwave with 4 power levels
- Microwave & grill
- Grill
- Defrosting
- 3-pane glass cool-touch door

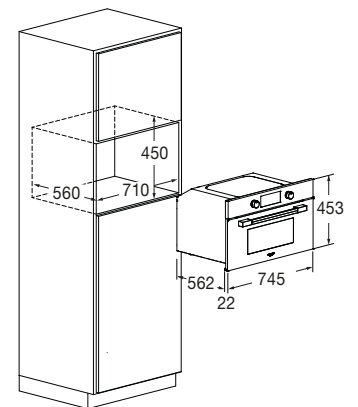

## Features

This product stands out for its classic user-friendly knob control completed with a functional digital display. The various timing functions are easy to set and clearly intelligible. The oven features a 34 l stainless steel cooking chamber. Moreover, it's fitted with an efficient safety system, including a door with a safety lock, a door contact switch, and tangential cooling ventilation. The appliance comes with the following accessories: a glass turntable plate, a flat grill rack and a round grill rack.



STAINLESS STEEL  
FUGMO 7505 MT IX  
EAN 8019801032112

# URBANTECH

MICROWAVE OVEN 75X45



<b>FUGMO 7505 MT IX</b>	
Type	Microwave with grill
Estetica	Stainless steel
<b>FEATURES</b>	
Interiors: enamelled / other	Stainless steel
Capacity (litres)	34 L
Forced cooling	•
Functions no.	3
<b>PERFORMANCE</b>	
Max cooking temperature	230 °C
Grill power (W)	1500 W
Microwave power (W)	900 W
Microwave power levels	6
Cooking with Grill	•
<b>CONTROLS</b>	
Control type	Digital timer + Knobs
Auto power off	•
<b>SAFETY</b>	
Safe door / no. of glass panes	• / 3
<b>ACCESSORIES</b>	
Flat grill racks no.	1
Round grill rack / Glass turntable plate	• / •
<b>POWER RATING</b>	
Max electrical power (W)	3200 W
Voltage / Frequency (V - Hz)	220 - 240 V; 50 Hz
Power cord	•
Plug	Schuko
<b>DIMENSIONS</b>	
Width (mm)	745
Height (mm)	452
Depth (mm)	561
Built-In Cut Out (W x H x D) mm	710 x 450 x 560