

24" TOUCH CONTROL SELF-CLEAN OVEN















MODEL CODE

MATTEO 700 SERIES

F7MSP24MB1



-  **CREACTIVE COOKING SYSTEM**
-  **PIZZA COOKING MODE 590°F**
-  True Convection
-  Self Clean Oven
-  Multi-level Cooking
-  Soft Closing
-  Cool Touch Door
-  TFT Display
-  Meat Probe
-  Fast Pre-Heat
-  Air Fry
-  Americans with Disabilities Act †

DESCRIPTION

The Matteo 700 Series 24" oven combines sleek style with modern innovation. Its matte black finish elevates your kitchen while offering reliable performance for all your cooking needs. Featuring preset cooking functions for effortless meal prep, child safety locks, and cool-touch doors for peace of mind, this oven is designed with your safety in mind. Self-cleaning capabilities, a dual convection system, and oversized capacity provide flexibility and optimal cooking results. Perfect for ADA-compliant installations, it's the ideal fusion of luxury, convenience, and performance.

FEATURES

- Full Touch Controls
- Display TFT 3.5"
- 4 Heat-resistant Glass Panel
- Cool Touch Door
- Soft Closing Door
- Interior Halogen Light
- Preset Default Temperature
- Setting Weight kg/lb
- Display Brightness Setting (ON/OFF Condition)
- Beeper Volume Setting
- Display Control Lock
- Sabbath Mode
- 12/24-Hour Clock Formats
- Automatic Fast Preheat
- Temperature Display °C / °F
- Meat Probe
- Event Log (for Service)

FUNCTIONS

- Bake
- Roast
- True Convection
- Convection Roast
- Convection Bake
- Broil
- Convection Grill
- Convection Broil
- Pizza
- Pizza Pizzeria
- Defrost
- Dehydrate
- Warm
- Warm Plus
- Air Fry
- Self Clean

INCLUDED ACCESSORIES

- | | |
|--------------|----------------------|
| 2 x 12200230 | Chromed rack |
| 42105299 | Enameled broiler pan |
| 42105652 | Air Fry tray |
| 12541020 | Meat Probe |

OPTIONAL ACCESSORIES

- | | |
|--------|-----------------------|
| FMTELG | 24" Telescopic Guides |
|--------|-----------------------|

† To achieve full ADA compliance, please consult the current ADA requirements for product installation instructions.

24" TOUCH CONTROL SELF-CLEAN OVEN



MODEL CODE

MATTEO 700 SERIES

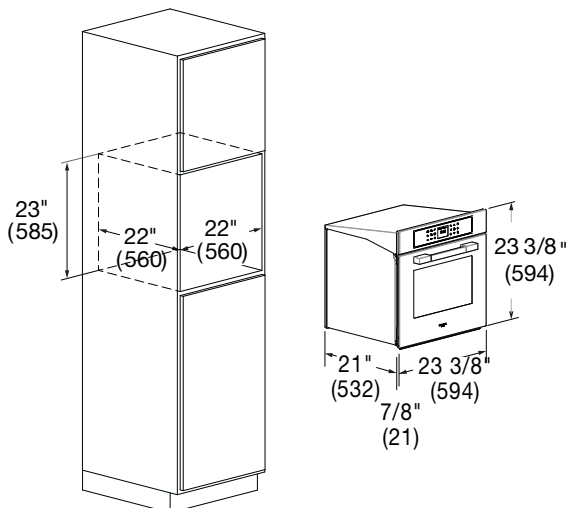
F7MSP24MB1

MODEL CODE	24" TOUCH CONTROL SELF CLEAN OVEN F7MSP24MB1	
GENERAL DETAILS		
Finish	Matte Black	
Control Type	Creative Electronic Touch Control	
Display	3.5" TFT	
Language	English (USA) / English (UK) / French / Spanish / Italian / German	
Oven Type	True Convection	
Temperature (min - max), °F (°C)	170 - 550	(75 - 290)
Soft Closing	Yes	
Rack Positions	5	
Interior Lights	2 x 25 Halogen	
Pyrolytic Self Clean	Yes	
CAPACITY		
Volume (each), cu. ft. (L)	2.36	(66.8)
Useable Width, in. (mm)	18-1/8	(460)
Useable Height, in. (mm)	13-3/4	(350)
Useable Depth, in. (mm)	16-5/16	(415)
DIMENSIONS / WEIGHT		
Product Width, in. (mm)	23-3/8	(594)
Product Height, in. (mm)	23-3/8	(594)
Product Depth, in. (mm)	21	(532)
Cutout Width, in. (mm)	22	(560)
Cutout Height (min), in. (mm)	23	(585)
Cutout Depth (min), in. (mm)	22	(560)
Net Weight, lbs. (kg)	99	(45)
POWER / RATINGS (240 V, 60 Hz)		
Broil Upper Heating Element	1200 W	
Upper Auxiliary Element	1000 W	
Concealed Lower Bake Element	1100 W	
Convection Element	2300 W	
TECHNICAL DETAILS		
kW / Amps rating at 120-240 V, 60 Hz	3.45 kW - 14.3 A	
kW / Amps rating at 120-208 V, 60 Hz	2.59 kW - 12.4 A	
Power Cable	4-Wire Conduit – Hardwire Connection	
Power Cable Length, in. (mm)	56	(1422)
Electrical Circuit	240 / 208 V - 60 Hz - 40 A	
INSTRUCTIONS FOR USE		
Use & Care Manual / Installation Manual	English / French / Spanish	
WARRANTY		
Limited Warranty	Parts and Labor (2-year)	