

30" COMBI SPEED OVEN













MODEL CODE

MATTEO 700 SERIES

F7MSPD30S1



-  **CREACTIVE COOKING SYSTEM**
-  Microwave Cooking
-  Defrost
-  True Convection
-  Automatic Cooking
-  Cool Touch Door
-  Multi-level Cooking
-  TFT Display
-  Air Fry
-  Americans with Disabilities Act †

DESCRIPTION

The Matteo 700 series 30" combi speed oven, finished in fingerprint-resistant stainless steel, combines sleek, modern style with the functionality of a 3-in-1 specialty oven. This versatile appliance works as a microwave, conventional oven, or a combination of both, offering faster cooking times without sacrificing flavor. Ideal for busy households, its combination speed modes deliver the rich taste of traditional oven-cooked meals with microwave efficiency. With preset functions for precision cooking, this oven brings luxury, speed, and flexibility to your kitchen, making gourmet meals effortless.

FEATURES

- 3-in-1 Oven (Microwave, Convection, Combi)
- Microwave mode (6 levels)
- 10 functions
- Automatic Cooking
- Fan Assisted mode
- Defrost by Weight and Time
- Pre-selected and Customizable Recipes
- Stainless Interior with Broiler
- TFT Display with Touch Controls
- Quick Access Menu
- Dual Keypad

FUNCTIONS

- Microwave
- Microwave Broil
- Microwave Convection
- Defrost by Time
- Defrost by Weight
- True Convection
- Convection Broil
- Fan & Broil
- Air Fry
- Broil
- Popcorn
- Poultry
- Meat
- Fish
- Vegetables
- Desserts
- Bread/Pizza

INCLUDED ACCESSORIES

- 12200460 Chromed rack
- 42702000 Chromed round stand
- 12105500 Stainless Steel tray

† To achieve full ADA compliance, please consult the current ADA requirements for product installation instructions.

30" COMBI SPEED OVEN



MODEL CODE

MATTEO 700 SERIES

F7MSPD30S1

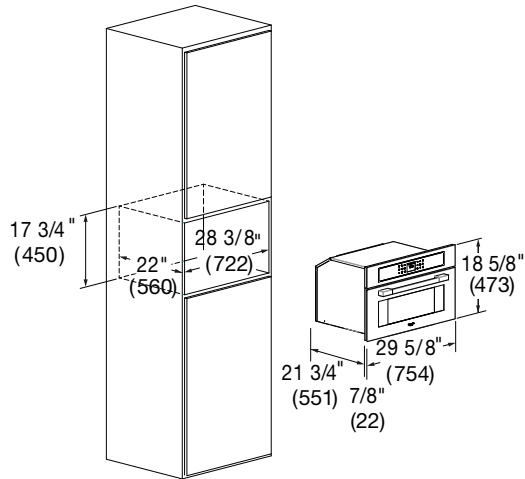

MODEL CODE	30" COMBI SPEED OVEN F7MSPD30S1	
GENERAL DETAILS		
Finish	Stainless Steel	
Control Type	Dual Touch Electronic Keypads	
Display	3.5" TFT	
Language	English (USA) / English (UK) / French / Spanish / Italian / German	
FEATURES		
Oven Type	Microwave Speed Oven	
Oven Cavity	Stainless Steel	
Door Glass	Cool Touch	
Rack Positions	3	
Interior Light	1 x 20 W Halogen	
CAPACITY		
Volume, cu. ft. (L)	1.46	(41.3)
Useable Width, in. (mm)	16-9/16	(420)
Useable Height, in. (mm)	10	(254)
Useable Depth, in. (mm)	15-1/4	(387)
DIMENSIONS / WEIGHT		
Product Width, in. (mm)	29-5/8	(754)
Product Height, in. (mm)	18-5/8	(473)
Product Depth, in. (mm)	21-3/4	(551)
Cutout Width, in. (mm)	28-3/8	(722)
Cutout Height (min), in. (mm)	17-3/4	(450)
Cutout Depth (min), in. (mm)	22	(560)
Recess (WxHxD), in. (mm)	28-3/8 x 17-3/4 x 22	(722 x 450 x 560)
Net Weight, lbs. (kg)	93	(42)
POWER / RATINGS		
Broil Upper Heating Element	1500 W	(240)
Convection Element	2300 W	(240)
Microwave Input	1850 W	
Microwave Output	900 W	
Microwave Frequency	2450 mHz	
Supply voltage, V/Hz	208/240 V / 60 Hz	
kW / Amps rating at 120-240 V, 60 Hz	3.4 kW - 14 A	
kW / Amps rating at 120-208 V, 60 Hz	2.7 kW - 13 A	
Power Cable	Conduit	
INSTRUCTIONS FOR USE		
Use & Care Manual / Installation Manual	English / French / Spanish	