

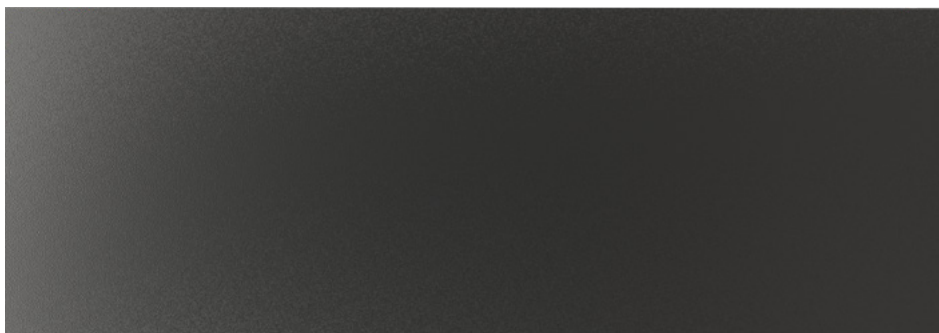







30" WARMING DRAWER

MATTEO 700 SERIES

MODEL CODE

F7MWD30MB1



-  Keep Warm
-  Defrost
-  Proofing
-  Push Opening
-  Slow Cooking
-  Sliding Telescopic Rails
-  Americans with Disabilities Act †

DESCRIPTION

The Matteo 700 series 30" warming drawer, featuring our exclusive matte black finish, redefines versatility in the kitchen. With its innovative true convection design, this drawer does more than just keep food warm—it also excels at slow cooking, proofing, dehydrating, and defrosting, all within a compact, fully enclosed space. The convection fan ensures even heat distribution from top to bottom, making it the perfect solution for keeping side dishes, pies, or bread at just the right temperature. Stylish, functional, and practical, the 700 series warming drawers are indispensable additions to any modern kitchen.

FEATURES

- Knob Control
- Heavy Duty full extension rails
- Large capacity 1.9 cu. ft. (53.3 L)
- True convection heating system
- Even heat distribution
- All stainless steel structure
- Warming Temperature range: min. 90 °F up to 195 °F (min. 30 °C up to 90 °C)
- Push latch system to open and close the drawer
- 2 Internal lights

FUNCTIONS

- Pre-heat dishes
- Pre-heat coffee cups
- Keep warm ready food
- Defrosting
- Leavening dough
- Slow cooking min. 90 °F up to 195 °F (min. 30 °C up to 90 °C)

† To achieve full ADA compliance, please consult the current ADA requirements for product installation instructions.

30" WARMING DRAWER

MATTEO 700 SERIES

MODEL CODE

F7MWD30MB1

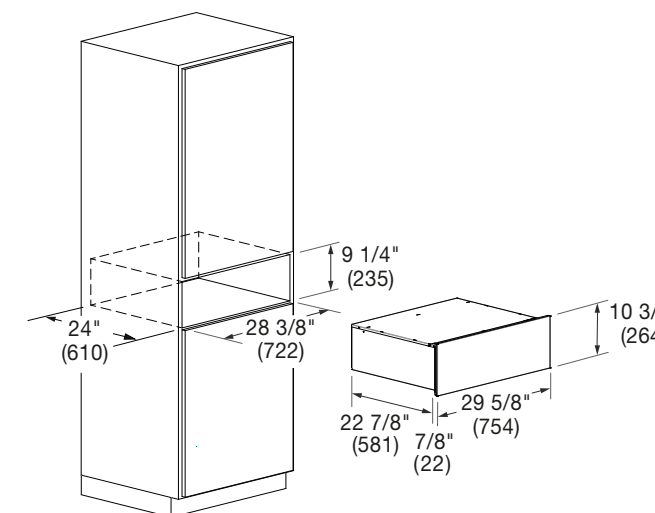

MODEL CODE	30" WARMING DRAWER F7MWD30MB1	
GENERAL DETAILS		
Finish	Matte Black	
Control Type	Electronic Knob	
Compatible Ovens	F7MSPD30MB1 - F7MSCO30MB1 - F7MSP30MB1	
Temperature (max), °F (°C)	195	(90)
Thermostat, °F (°C)	90 - 195	(30 - 90)
Interior Lights	2 x 20 W Halogen	
CAPACITY		
Volume (each), cu. ft. (L)	1.9	(53.3)
Useable Width, in. (mm)	24-3/8	(620)
Useable Height, in. (mm)	7-7/8	(200)
Useable Depth, in. (mm)	16-7/8	(430)
DIMENSIONS / WEIGHT		
Product Width, in. (mm)	29-5/8	(754)
Product Height, in. (mm)	10-3/8	(264)
Product Depth, in. (mm)	22-7/8	(581)
Door Depth with Overlay	1	(23)
Cutout Width, in. (mm)	28-3/8	(722)
Cutout Height (min), in. (mm)	9 1/4	(235)
Cutout Depth (min), in. (mm)	24	(610)
Net Weight, lbs. (kg)	67.2	(30.5)
POWER / RATINGS		
Max power absorbed (W)	1100 W	
Power V (Hz)	120	(60)
Power Cable	NEMA 5-15P	
Power Cable Length, in. (mm)	86 5/8	(2200)
INSTRUCTIONS FOR USE		
Use & Care Manual / Installation Manual	English / French / Spanish	
WARRANTY		
Limited Warranty	Parts and Labor (2-year)	